

# Señalética y Grafismo

## *Signage and Graphics*

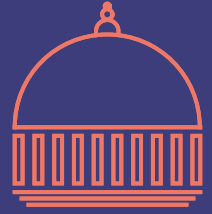

## **01** Fibes 1

## **02** Fibes 2

## **03** Elementos Autoportantes /

*Self-supporting Elements*

## **04** Personalización Stand Modulares /

*Custom Shell Scheme Graphic Solutions*

# 01 Fibes 1

## Fachada principal Cúpula / Main facade Dome

Fibes 1-01



**Material:** Lona PVC microperforada con jaretón superior e inferior  
*Micro-perforated PVC canvas with upper and lower drawstring*

**Medidas:** 22,06 X 3,98 m  
*Measures: 22.06 X 3.98 m*

## Fachada principal Cúpula / Main facade Dome

Fibes 1-02



**Material:** Lona PVC microperforada con jaretón superior e inferior  
*Micro-perforated PVC canvas with upper and lower drawstring*

**Medidas:** 2, 54 X 3,98 m cada unidad  
*Measures: 2. 54 X 3.98 m each unit*

## Cúpula / Dome

Fibes 1-03



**Material:** Lona PVC frontlit

*PVC Frontlit Canvas*

**Medidas:** 2,24 x 4,04 m lona corta y 2,24 x 5,54m lona larga

*Measures: 2.24 x 4.04 m short canvas and 2.24 x 5.54 m long canvas*



## Cúpula / Dome

Fibes 1-04



**Material:** Lona larga PVC frontlit

*Long frontlit PVC*

**Medidas:** 2,12 X 9,00 m cada unidad

*Measures: 2.12 X 9.00 m each unit*

## Cúpula / Dome

Fibes 1-05



**Material:** Lona balcón PVC frontlit  
*PVC Frontlit balcony canvas*

**Medidas:** 2,24 x 1,53 m 1 Unidad  
*Measures: 2.24 x 1.53 m 1 unit*



## Entrada Pabellón / Pavilion Entrance



Fibes 1-06

**Material:** Foam impreso 10 mm espesor

*Printed 10 mm Foam*

**Medidas:** 3,50 x 1,01 m

*Measures: 3.50 x 1.01 m*

Interior Pabellón / Inside Pavilion

Fibes 1-07



**Material:** Cubos gráficos realizados mediante estructura interna de madera con lonas PVC graficas exteriores

*PVC Graphic Cubes. Inner structure in wood to cover with PVC printed Canvas (5 sides printed)*

**Medidas:** 2,00 x 2,00 m 1 Unidad

*Measures: 2.00 x 2.00 m 1 Unit*

Interior Pabellón / Inside Pavilion

Fibes 1-08



**Material:** Lona PVC frontlit doble cara  
*PVC Frontlit Canvas. Double-sided printing*

**Medidas:** 1,00 x 3,00 m 1 Unidad  
*Measures: 1.00 x 3.00 m 1 Unit*



**Entrada Auditorio Al-Andalus / Al-Ándalus Auditorium. Main Entrance**

Fibes 1-09



**Material:** Lona PVC frontlit  
*PVC Frontlit Canvas*

**Medidas:** 4,00 x 1,50 m  
*Measures: 4.00 x 1.50 m*

## Interior cúpula escaleras / Indoor Dome Hall

Fibes 1-10

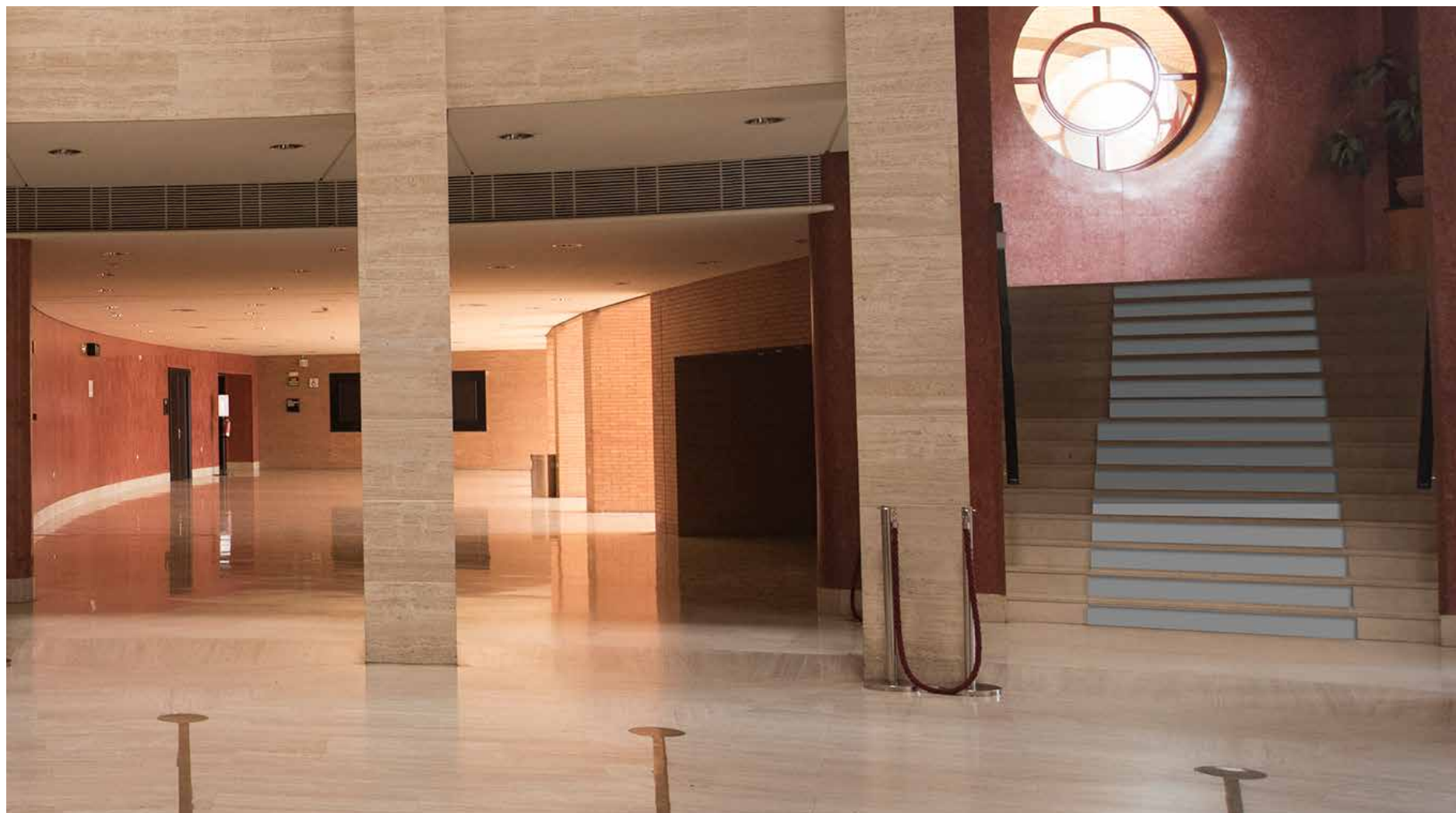

**Material:** Vinilo adhesivados sobre contrahuella escaleras acceso planta 1

*Printed vinyl. Staircase to first floor*

**Medidas:** 0,14 x 1,50 m

*Measures: 0.14 x 1.50 m*



## 02 Fibes 2

## Fachada Rampa / Facade Ramp

Fibes 2-01



**Material:** Lona PVC frontlit. Realizada en tres paños unidos por termosellado

*PVC Frontlit Canvas. Made in three cloths joined by heat sealing*

**Medidas:** 16,00 x 6,05 m

*Measures: 16.00 x 6.05 m*

## Fachada Rampa / Facade Ramp

Fibes 2-02



**Material:** Lona PVC frontlit. Realizada en una sola pieza

*PVC Frontlit Canvas. Made in one piece*

**Medidas:** 16,00 x 5,00 m

*Measures: 16.00 x 5.00 m*

## Fachada Rampa / Facade Ramp

Fibes 2-03

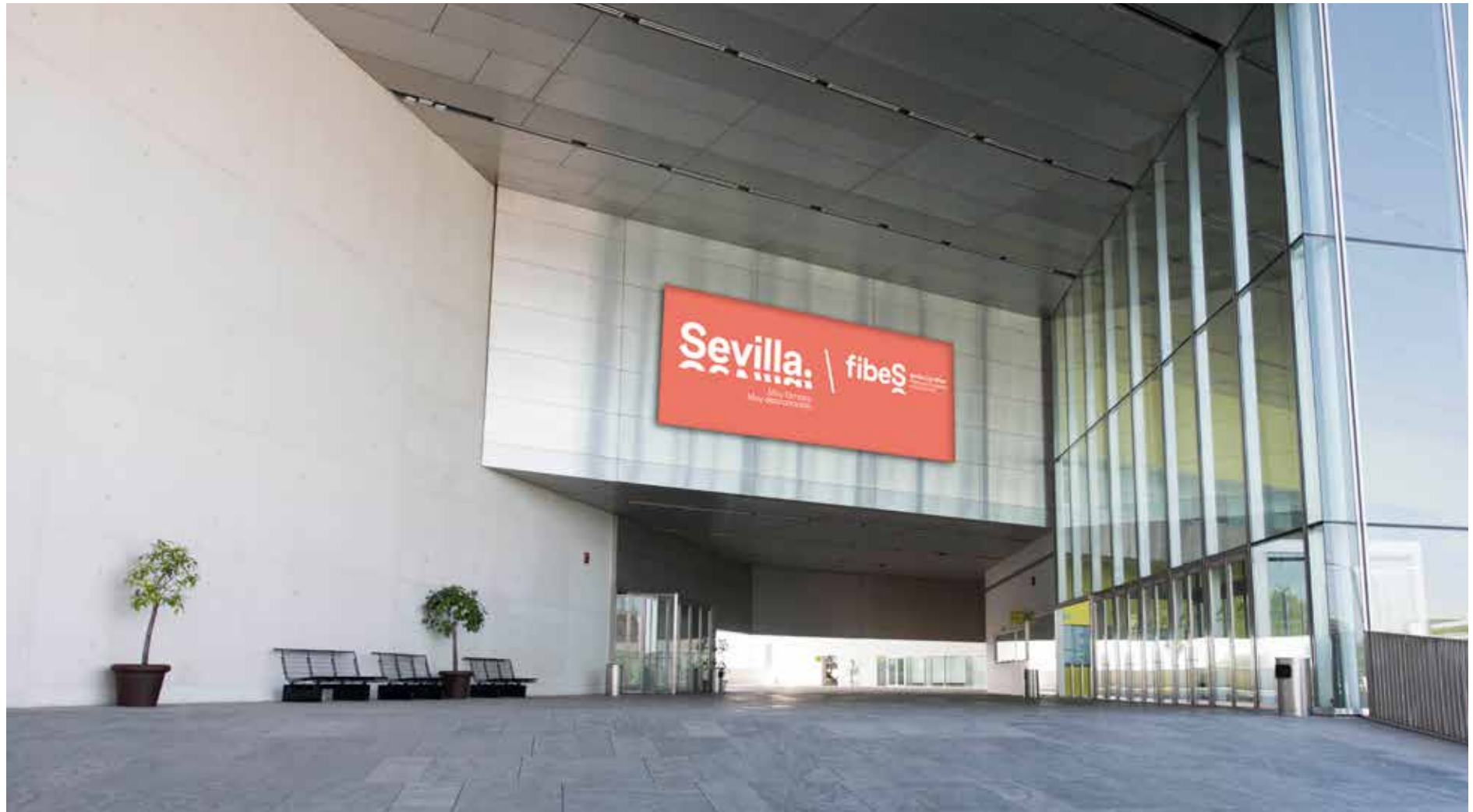

**Material:** Lona PVC frontlit  
*PVC Frontlit Canvas*

**Medidas:** 8,00 x 4,00 m  
*Measures: 8.00 x 4.00 m*



## Fachada Rampa / Facade Ramp

Fibes 2-04



**Material:** Vinilo impreso con laminado suelo

*Printed vinyl flooring*

**Medidas:** 3 m de diámetro

*Measures: 3 m diameter*



## Fachada Rampa / Facade Ramp

Fibes 2-05



**Material:** Cubos gráficos realizados mediante estructura interna de madera con lonas PVC graficas exteriores

*Graphical cubes made by internal structure of wood with graphics PVC*

**Medidas:** 2,00 x 2,00 m 1 Unidad

*Measures: 2.00 x 2.00 m 1 Unit*

**Terraza rampa barandilla exterior / Terrace ramp. Outdoor Railing**



**Material:** Lona PVC impresa grapeada a bastidor o fijada a barandilla

*Printed PVC canvas engraved on rack or attached to railing*

**Medidas:** 1 tramo: 13,60 x 1,10 m. 2 tramo: 14,14 x 1,10 m. 3 tramo: 15,70 x 1,10 m

*Measures: 1 section: 13.60 x 1.10 m. 2 section: 14.14 x 1.10 m. 3 section: 15.70 x 1.10 m*

## Terraza 1 rampa interior / Terrace 1 interior ramp

Fibes 2-07



**Material:** Parte inferior: PVC con vinilo impreso. Parte superior: Lona PVC impresa con ollaos perimetral sobre barandilla o grapeada a bastidor de madera

*Bottom: PVC with printed vinyl. Upper: PVC canvas printed with perimeter grommets on railing or woodgrain to wooden frame*

**Medidas:** en la foto

*Measures: in the photo*



Terraza 2 rampa interior / Terrace 2 interior ramp

Fibes 2-08

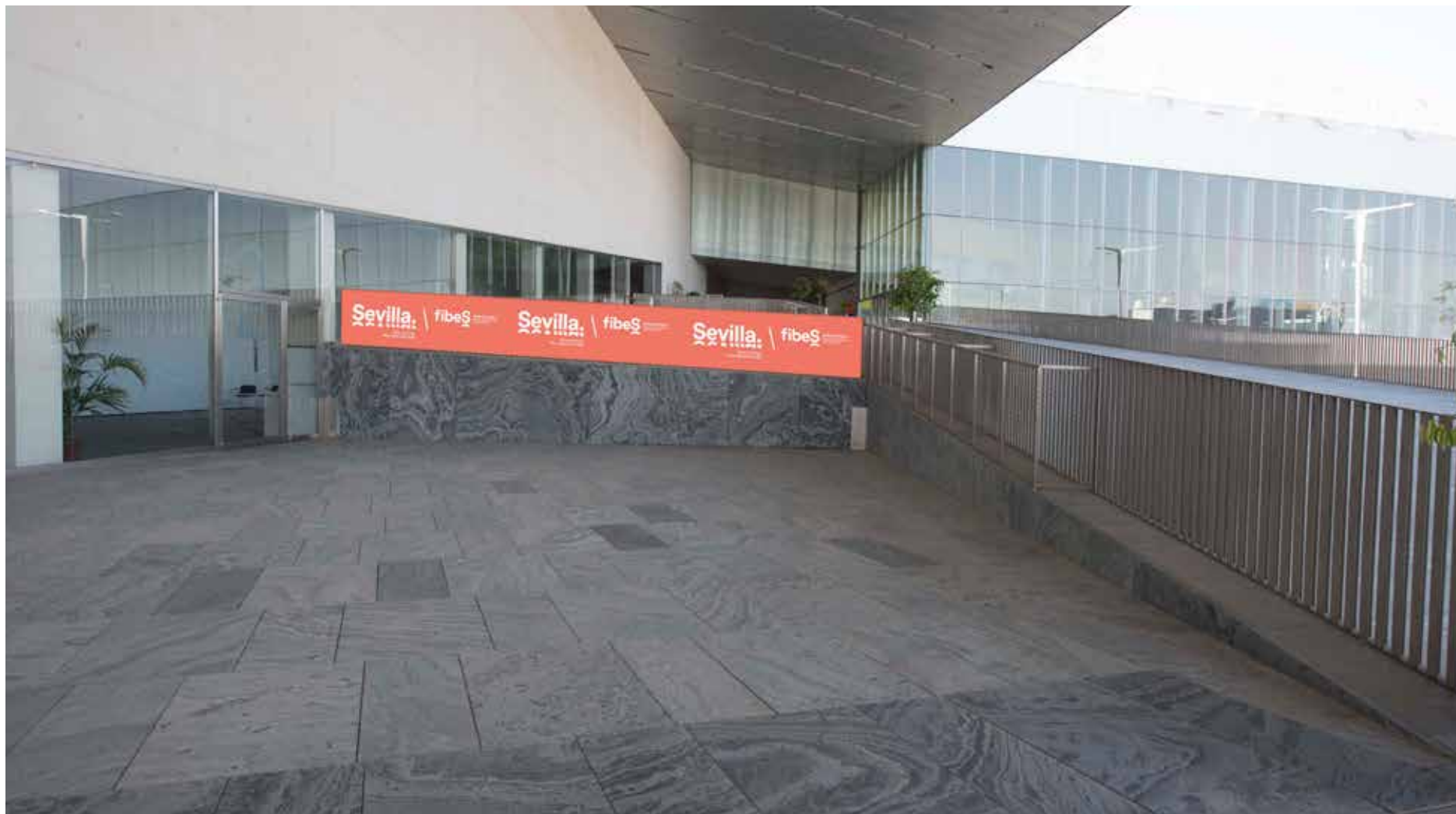

**Material:** Lona PVC impresa con ollaos perimetral sobre barandilla o grapeada a bastidor de madera

*Canvas PVC printed with perimetral grommets on railing or grating to wooden frame*

**Medidas:** 9,84 x 1,10 m

*Measures: 9.84 x 1.10 m*

Terraza 3 rampa interior / Terrace 3 interior ramp

Fibes 2-09



**Material:** Lona PVC impresa con ollaos perimetral sobre barandilla o grapeada a bastidor de madera

*Canvas PVC printed with perimetral grommets on railing or grating to wooden frame*

**Medidas:** 6,84 x 1,10 m

*Measures: 6.84 x 1.10 m*



## Terrazas rampa interior. Puerta 1 / Terraces Indoor ramp. Gate 1

Fibes 2-10



**Material:** Vinilo microperforado

*Microperforated vinyl*

**Medidas:** ver foto

*Measures: view photo*

Terrazas rampa interior. Puerta 2 / Terraces Indoor ramp. Gate 2

Fibes 2-11



**Material:** Vinilo microperforado

*Microperforated vinyl*

**Medidas:** ver foto

*Measures: view photo*

**Terrazas rampa interior. Puerta 3 / Terraces Indoor ramp. Gate 3**

Fibes 2-12



**Material:** Vinilo microperforado

*Microperforated vinyl*

**Medidas:** ver foto

*Measures: view photo*

## Módulo A interior / Indoor Module A

Fibes 2-13

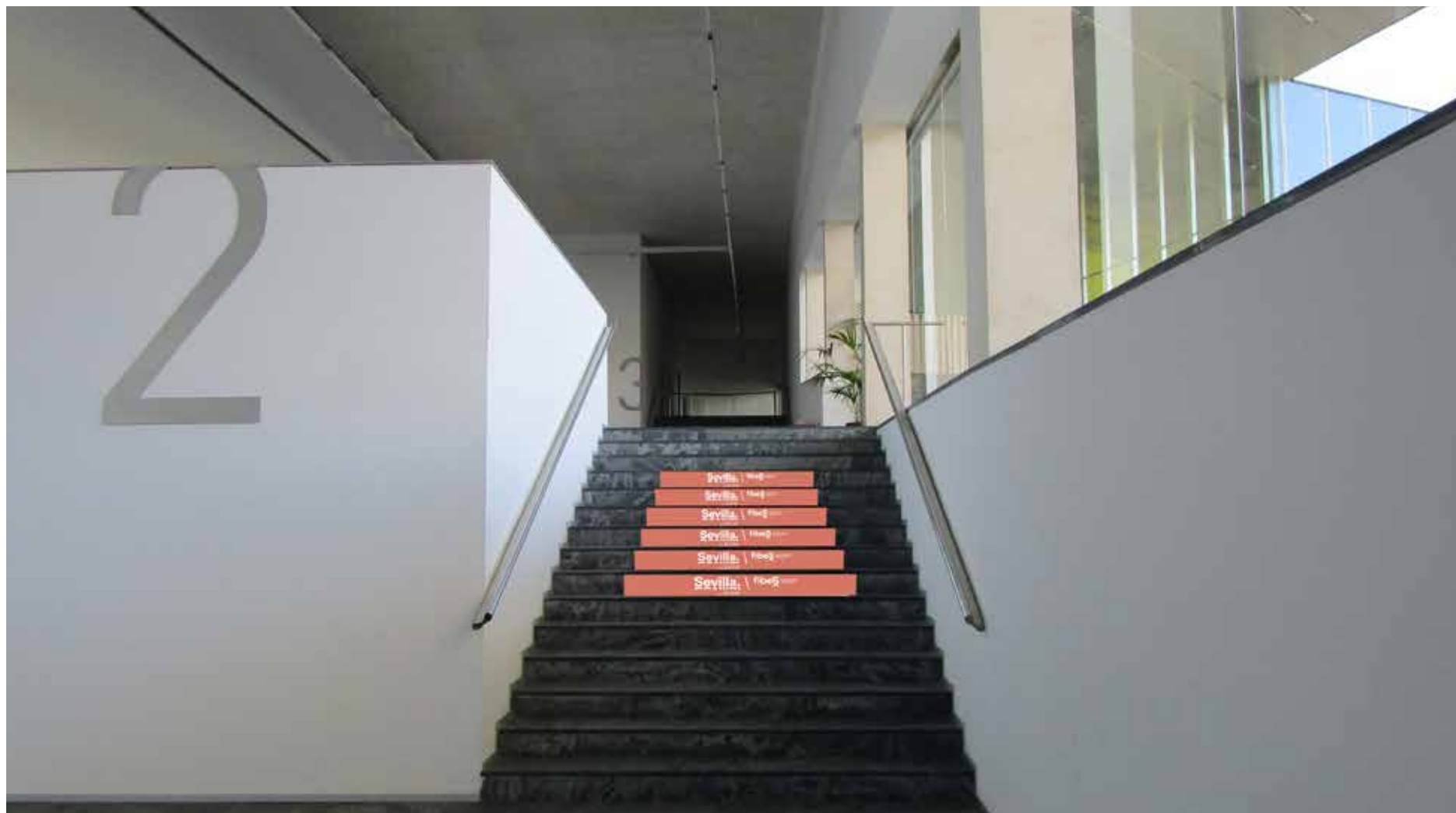

**Material:** Vinilo impreso /  
*Printed vinyl*

**Medidas:** 0,15 m de altura por largo variable  
*Measures: 0.15 m height by variable length*



Módulo A interior / Indoor Module A

Fibes 2-14



**Material:** Totems con impresión de vinilo

*Totem display with printed vinyl*

**Medidas:** 2,00 x 1,00 m x 3, 70 m altura

*Measures: 2.00 x 1.00 m x 3. 70 m altura*

## Fachada Principal / Main Facade

Fibes 2-15



**Material:** Vinilo HOP cristal con trasera blanca opaca/

*Vinyl HOP crystal with opaque white back*

**Medidas:** 1,970 x 3,995 m. 1 Unidad de ventana

*Measures: 1.970 x 3.995 m. 1 window unit*

## Plaza Exterior / Outdoor Square

Fibes 2-16



**Material:** Lona PVC opaca impresa a doble cara con vaina superior y vainas laterales para antivuelco

*Double-sided printed opaque PVC canvas with top sheath and side sheaths for anti-tip*

**Medidas:** 0,85 x 2,00 m

*Measures: 0.85 x 2.00 m*



## Zona Salida Parking / Exit Parking

Fibes 2-17



**Material:** Lona PVC frontlit impresa

*PVC Frontlit Canvas*

**Medidas:** 10,00 x 3,10 m

*Measures: 10.00 x 3.10 m*



Fachada Hall Planta 0 / Facade Ground Floor Hall 0

Fibes 2-18



**Material:** Vinilo microperforado ideal para cristales, permite una visión del 50% desde dentro hacia fuera

*Micro-perforated vinyl ideal for glass, allows a 50% view from the inside out*

**Medidas:** A= 1,86 x 4,22 m, B= 1,67 x 4,22 m, C= 1,67 x 4,08 m, D= 1,67 x 4,08 m

*Measures: A= 1.86 x 4.22 m B= 1.67 x 4.22 m C= 1.67 x 4.08 m D= 1.67 x 4.08 m*

Fachada Hall Planta 0 / Facade Ground Floor Hall 0

Fibes 2-19



**Material:** Vinilo microperforado ideal para cristales, permite una visión del 50% desde dentro hacia fuera

*Micro-perforated vinyl ideal for glass, allows a 50% view from the inside out*

**Medidas:** 0,730 x 2,23 m

*Measures: 0.730 x 2.23 m*

## Hall Planta 0. Acreditaciones / Ground Floor Hall. Accreditations

Fibes 2-20



**Material:** A y B vinilo impreso

*A and B printed vinyl*

**Medidas:** A=7,81 x 1,10 m / B= 5,19 x 0,75 m

*Measures: A=7.81 x 1.10 m / B= 5.19 x 0.75 m*



**Hall Planta 0. Acreditaciones, Pasarela 1 / Ground Floor Hall. Accreditations. Footbridge 1**



**Material:** Vinilo impreso sobre placas de aluminio

*Printed vinyl on sheet*

**Medidas:** 1 = 2,89 x 1,16 m / 2-7 = 2,81 x 1,16 m / 8 = 2,76 x 1,16 m. **MEDIDA TOTAL: 22,51 x 1,16 m**

*Measures: 1 = 2.89 x 1.16 m / 2-7 = 2.81 x 1.16 m / 8 = 2.76 x 1.16 m TOTAL: 22.51 x 1.16 m*



## Hall Planta 0. Acreditaciones, Pasarela 2 / Ground Floor Hall. Accreditations. Footbridge 2

Fibes 2-22



**Material:** Vinilo impreso sobre placas de aluminio

*Printed vinyl on sheet*

**Medidas:** 1 = 2,66 x 1,16m/ 2 = 2,63 x 1,16m/ 4 3, 4, 5 = 2,67 x 1,16m/ 6 = 2,77 x 1,16m. TOTAL: 16,07 x 1,16 m

*Measures: 1 = 2.66 x 1.16m/ 2 = 2.63 x 1.16m/ 4 3, 4, 5 = 2.67 x 1.16 m / 6 = 2.77 x 1.16m TOTAL : 16.07 x 1.16 m*

## Hall Planta 0. Pasarela 2 / Ground Floor Hall. Footbridge 2

Fibes 2-23



**Material:** Lona PVC fronlit fijada sobre barandilla superior

*PVC Frontlit Canvas fixed on the upper railing*

**Medidas:** 1= 2,67 x 2,13 m/ 2=1,50 x 2,13 m visto, los anchos de las lonas son variables

*Measures: 1= 2.67 x 2.13 m / 2=1.50 x 2.13 m seen, the widths of the canvases are variable*

## Hall Planta 0. Pasarela 3 / Ground Floor Hall. Footbridge 3

Fibes 2-24

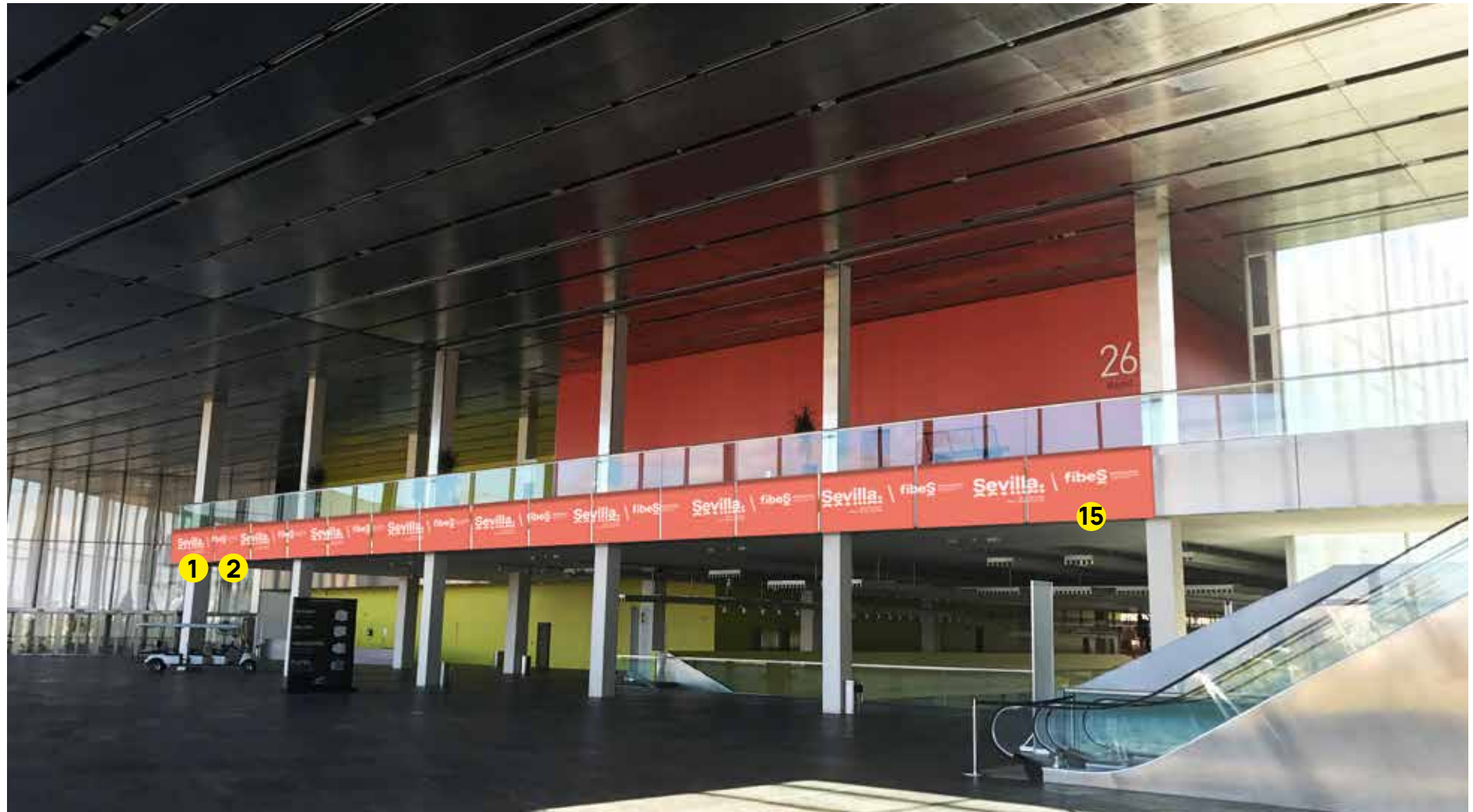

**Material:** Vinilo impreso sobre placas de aluminio

*Printed vinyl on sheet*

**Medidas:** 1 = 3,54x 1,16 m/2-15 = 2,67x 1,16 m. MEDIDA TOTAL: 40,92 x 1,16 m

*Measures: 1=3.54x1.16m/2-15=2.67x1.16m TOTAL: 40.92 x 1.16 m*



Hall Planta 0. Pasarela 4. Zona Bar / Ground Floor Hall. Bar Area. Footbridge 4



Fibes 2-25

**Material:** Vinilo impreso sobre placas de aluminio

*Printed vinyl on sheet*

**Medidas:** 1-4 = 2,29 x 1,16 m / 5 = 2,40 x 1,16 m MEDIDA TOTAL: 11,56 x 1x16 m

*Measures: 1-4 = 2.29 x 1.16 m / 5 = 2.40 x 1.16 m TOTAL SIZE: 11.56 x 1x16 m*



Hall Planta 0. Pasarela 5. Zona Bar / Ground Floor Hall. Bar Area. Footbridge 5



Fibes 2-26

**Material:** Vinilo impreso sobre placas de aluminio

*Printed vinyl on sheet*

**Medidas:** 1 = 3,44x 1,16 m / 2-8 = 2,67x 1,16 m. MEDIDA TOTAL: 22,13 x 1,16 m

*Measures: 1 = 3.44x 1.16 m / 2-8 = 2.67x 1.16 m. MEDIDA TOTAL: 22.13 x 1.16 m*

Hall Planta 0 / Hall Floor 0

Fibes 2-27



**Material:** Vinilo HOP cristal con trasera blanca opaca

*Vinyl HOP crystal with opaque white back*

**Medidas:** 16,71 x 0,97 m

*Measures: 16.71 x 0.97 m*

Hall Planta 0. Zona bar / Hall Floor 0. Bar area

Fibes 2-28



**Material:** Vinilo HOP cristal con trasera blanca opaca

*Vinyl HOP crystal with opaque white back*

**Medidas:** 15,08 x 0,96 m

*Measures: 15.08 x 0.96 m*



Planta 0 a Planta 1. Escalera fija / Floor 0 to Floor 1. Fixed ladder

Fibes 2-29

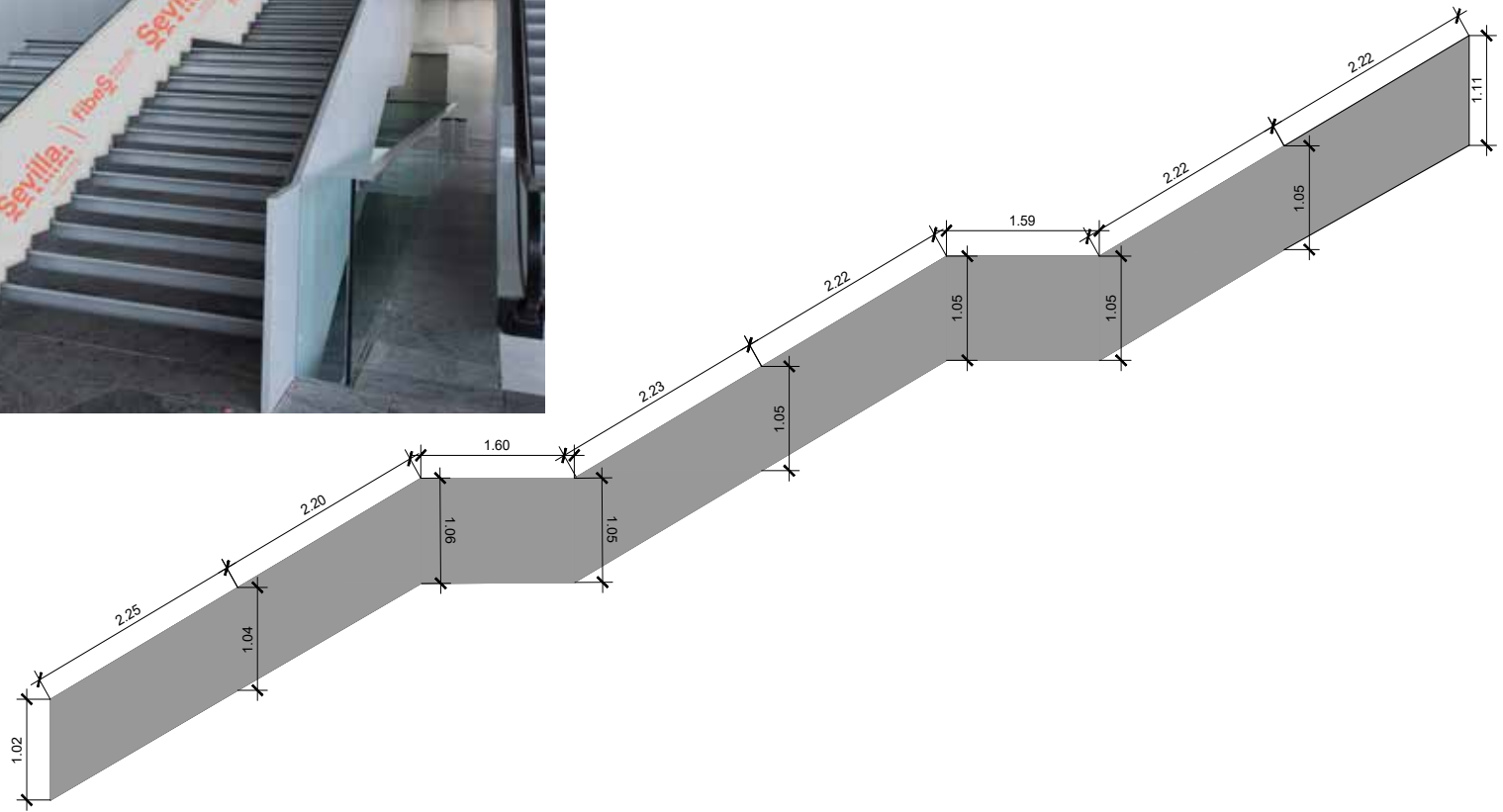

**Material:** Vinilo HOP cristal con trasera blanca opaca

*Vinyl HOP crystal with opaque white back*

**Medidas:** ver plano

*Measures: see map*



Planta 0 a Planta 1. Escalera fija/ Floor 0 to Floor 1. Fixed ladder

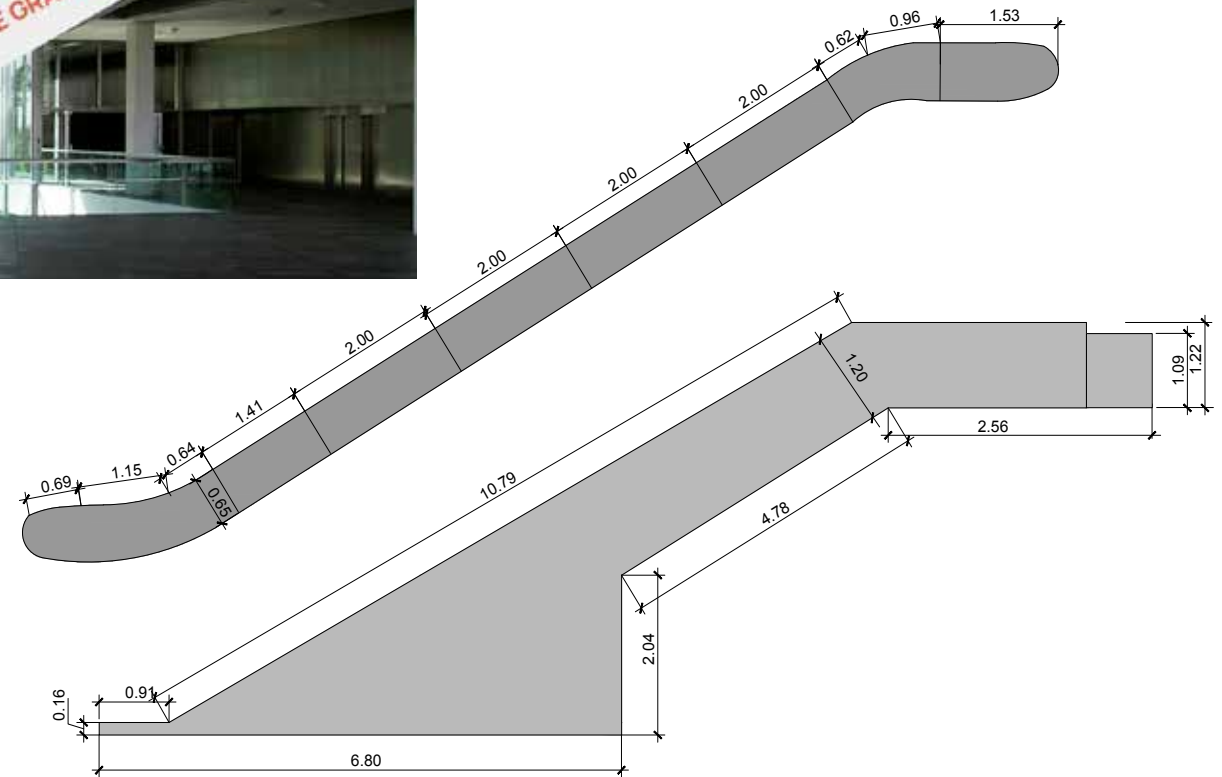

Fibes 2-30

**Material:** Vinilo HOP cristal con trasera blanca opaca  
Vinyl HOP crystal with opaque white back

**Medidas:** ver plano  
Measures: see map

Planta 1. Cristalera pasarela 3 / Floor 1. Glass Footbridge 3

Fibes 2-31



**Material:** Vinilo HOP cristal con trasera blanca opaca

*Vinyl HOP crystal with opaque white back*

**Medidas:** 40,74 x 0,97 m

*Measures: 40.74 x 0.97 m*

## Rampa acceso Catering / Ramp. Area Catering access

Fibes 2-32



**Material:** Vinilo HOP cristal con trasera blanca opaca

*Vinyl HOP crystal with opaque white back*

**Medidas:** 32,10 x 0,97 m

*Measures: 32.10 x 0.97 m*



## Zona Catering. Laterales / Catering Area. Sides



Fibes 2-33

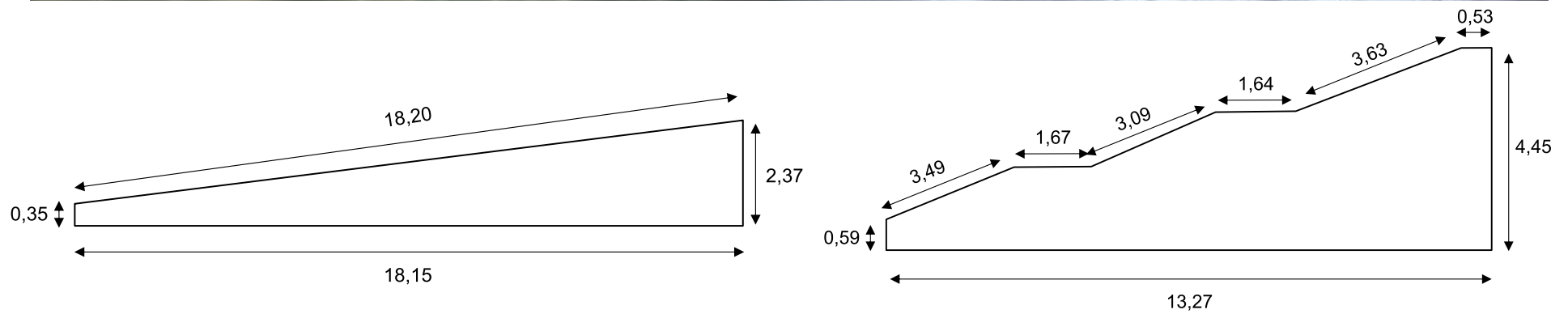

**Material:** Vinilo impreso/

*Printed vinyl*

**Medidas:** ver plano

*Measures: see map*



## Zona Catering / Catering Area

Fibes 2-34



**Material:** Vinilo HOP cristal con trasera blanca opaca

*Vinyl HOP crystal with opaque white back*

**Medidas:** 8 uds: 2,43 x 4,15 m. 8 uds: 2,43 x 3,42 m

*Measures: 8 units: 2.43 x 4.15 m 8 units: 2.43 x 3.42 m*

## Zona Catering. Pasarela / Catering Area. Footbridge

Fibes 2-35



**Material:** Lona gráfica pvc frontlit sobre dintel y fijado mediante soporte superior cada 10 m, se realiza por tramos

*PVC Frontlit canvas on the lintel. Upper support-fixed and placed every 10 m, produced by sections*

**Medidas:** 50,51 x 1,70 m

*Measures: 50.51 x 1.70 m*

## Ascensores. Placa Señalética / Elevators. Signage plate

Fibes 2-36



**Material:** Foam 5mm espesor

*Printed 5 mm Foam*

**Medidas:** 0,16 x 0,31 m

*Measures: 0.16 x 0.31 m*

**Planta 1. Aluminio subida escalera / Floor 1. Aluminum staircase climbing**

Fibes 2-37



**Material:** Vinilo impreso

*Printed vinyl*

**Medidas:** 1,04 x 2,44 m

*Measures: 1.04 x 2.44 m*



## Planta 1. Cristaleras salas panelables / Floor 1. Glass panels

Fibes 2-38



**Material:** Vinilo HOP cristal con trasera blanca opaca

*Vinyl HOP crystal with opaque white back*

**Medidas:** 2,44 x 3,43 m

*Measures: 2.44 x 3.43 m*

Planta 1 / Floor 1

Fibes 2-39



**Material:** Roll Up  
*Roll Up*

**Medidas:** 1,00 x 2,00 m  
*Measures: 1.00 x 2.00 m*

Planta 1 / Floor 1

Fibes 2-40



**Material:** Foam de 10 mm con vinilo impreso aplicado a doble cara

*10mm Foam with printed double-sided vinyl*

**Medidas:** 0,80 x 1,00 m

*Measures: 0.80 x 1.00 m*

Planta 1 / Floor 1

Fibes 2-41



**Material:** Vinilo impreso con laminado suelo

*Printed vinyl with laminate flooring*

**Medidas:** 0,80 x 0,80 m

*Measures: 0.80 x 0.80 m*



**Planta 1. Salas despachos / Floor 1. Office rooms**

**Fibes 2-42**



**Material:** Vinilo microperforado ideal para cristales, permite una visión del 50%

*Micro-perforated vinyl ideal for glass, allows 50% vision*

**Medidas:** 1,48 X 2,01 m. 1 Unidad

*Measures: 1.48 X 2.01 m 1 unit*

Planta 2. Pasillo despachos / Floor 2. Office foyers



Fibes 2-43

**Material:** Vinilo impreso

*Printed vinyl*

**Medidas:** 12,78 x 2,04 m

*Measures: 12.78 x 2.04 m*

## Auditorio. Cristales cabinas derecha / Auditorium. Crystals right cabins

Fibes 2-44



**Material:** Vinilo microperforado ideal para cristales, permite una visión del 50%

*Micro-perforated vinyl ideal for glass, allows 50% vision*

**Medidas:** Cabina 1 de 3,53 x 1,69 m / Cabina 2 de 3,72 x 1,69 m / Cabina 3 de 2,71 x 1,69 m

*Measures: Cabin 1 of 3.53 x 1.69 m / Cabin 2 of 3.72 x 1.69 m / Cabin 3 of 2.71 x 1.69 m*



Auditorio. Cristales cabinas izquierda / Auditorium. Crystals left cabins

Fibes 2-45



**Material:** Vinilo microperforado ideal para cristales, permite una visión del 50%

*Micro-perforated vinyl ideal for glass, allows 50% vision*

**Medidas:** Cabina 1 de 3,56 x 1,62 m / Cabina 2 de 3,81 x 1,62 m / Cabina 3 de 3,46 x 1,62 m

*Measures: Cabin 1 of 3.56 x 1.62 m / Cabin 2 of 3.81 x 1.62 m / Cabin 3 of 3.46 x 1.62 m*

## Auditorio. Pasarela lateral / Auditorium. Side Footbridge

Fibes 2-46



**Material:** Foam de 10 mm con vinilo impreso

*10 mm foam with printed vinyl*

**Medidas:** Tramo 1 de 2,54 x 1,72 m, Tramo 2, 3, 4, 5 de 2,96 x 1,72 m

*Measures: Section 1 of 2.54 x 1.72 m, Section 2, 3, 4, 5 of 2.96 x 1.72 m*

## **03 Elementos Autoportantes** / *Self-supporting Elements*

Photocall / Photocall

Elementos Autoportantes-1  
Self-supporting Elements-1



**Material:** Lona impresa  
*Printed canvas*

**Medidas:** 4,00 x 2,70 m  
*Measures: 4.00 x 2.70 m*



Atril / lectern

Elementos Autoportantes-2  
Self-supporting Elements-2



**Material:** Foam 5 mm con vinilo impreso

*Foam 5 mm with printed vinyl*

**Medidas:** 1 = 0,62 x 1,28 m / 2 = 0,64 x 0,64 m 1,16 m altura

*Measures: 1 = 0.62 x 1.28 m / 2 = 0.64 x 0.64m 1.16 m height*

## Podium / Podium

Elementos Autoportantes-3  
Self-supporting Elements-3



**Material:** Foam impreso 10 mm  
*Foam 10 mm with printed vinyl*  
**Medidas:** 0,96 x 1,52 m  
*Measures: 0.96 x 1.52 m*

## Display. Directorio / Display. Directory

Elementos Autoportantes-4  
Self-supporting Elements-4



**Material:** Lona impresa  
*Printed canvas*

**Medidas:** 1,80 x 2,40 m  
*Measures: 1.80 x 2.40 m*



Podium / Podium

Elementos Autoportantes-5  
Self-supporting Elements-5



**Material:** Foam impreso 10 mm  
*Foam 10 mm with printed vinyl*

**Medidas:** 0,46 x 1,52 m  
*Measures: 0.46x 1.52 m*

## Display / Display

### Elementos Autoportantes-6 Self-supporting Elements-6



**Material:** 1 = Display gráfico vinilo impreso triangular a 2 caras. 2 y 3= Display vinilo impreso a una o doble cara

1 = Triangular vinyl graphic display printed on 2 sides. 2 and 3= Vinyl display printed on one or both sides

**Medidas:** 1= 0,46 X 2,58 m / 2= 0,95 X 2,58 m / 3= 0,46 x 2,58 m

Measures: 1= 0.46 X 2.58 m / 2= 0.95 X 2.58 m / 3= 0.46 x 2.58 m

## Displays en zig-zag / Zig-zag displays

### Elementos Autoportantes-7

Self-supporting Elements-7



**Material:** Vinilo impreso

*Printed vinyl*

**Medidas:** 0,95 X 2,58 m 1 Unidad

*Measures: 0.95 X 2.58 m 1 unit*

## **04 Personalización Stand Modulares /**

### *Custom Shell Scheme Graphic Solutions*



Stand 4 x 4 Perfilería vista / Shell scheme Stand 4 x 4 Visible poles

Personalización Stand Modulares-1  
Custom Shell Scheme Graphic Solutions



**Material:** Vinilo impreso

*Printed vinyl*

**Medidas:** 1 = 0,95 x 2,58 m. 1 unidad / 2= 3,95 x 0,52 m

*Measures: 1 = 0.95 x 2.58 m 1 unit / 2= 3.95 x 0.52 m*

Stand 4 x 4 Perfilera oculta / Shell scheme Stand 4 x 4. Poles hidden

Personalización Stand Modulares-2

Custom Shell Scheme Graphic Solutions



**Material:** Foam impreso de 10 mm

*Printed 10 mm foam*

**Medidas:** 1 = 4,00 x 2,70 m / 2 = 3,95 x 0,52 m

*Measures: 1 = 4.00 x 2.70 m / 2 = 3.95 x 0.52 m*

## Stand 3 x 3 Perfilería vista / Shell scheme Stand 3 x 3 Visible poles

### Personalización Stand Modulares-3

Custom Shell Scheme Graphic Solutions



**Material:** Vinilo impreso

*Printed vinyl*

**Medidas:** 1 = 0,95 x 2,58 m 1 unidad / 2= 2,95 x 0,52 m 1 unidad

*Measures: 1 = 0.95 x 2.58 m 1 unit / 2= 2.95 x 0.52 m 1 unit*

## Stand 3 x 3 Perfilería oculta / Shell scheme Stand 3 x 3 Poles hidden

### Personalización Stand Modulares-4

Custom Shell Scheme Graphic Solutions



**Material:** Foam impreso de 10 mm

*Printed 10 mm foam*

**Medidas:** 1 = 3,00 x 2,70 m / 2= 2,95 x 0,52 m

*Measures: 1 = 3.00 x 2.70 m / 2= 2.95 x 0.52 m*



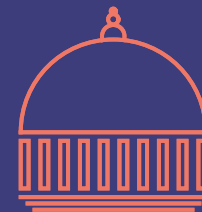

Avda. Alcalde Luis Uruñuela, 1 41020 Sevilla.

 954 47 87 00

 954 47 87 20

[www.fibes.es](http://www.fibes.es)