

Señalética y Grafismo

Signage and Graphics

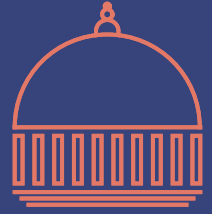

01 Fibes 1

02 Fibes 2

03 Elementos Autoportantes /

Self-supporting Elements

04 Personalización Stand Modulares /

Custom Shell Scheme Graphic Solutions

01 Fibes 1

Fachada principal Cúpula / Main facade Dome

Fibes 1-01



Material: Lona PVC microperforada con jaretón superior e inferior
Micro-perforated PVC canvas with upper and lower drawstring

Medidas: 22,06 X 3,98 m
Measures: 22.06 X 3.98 m

Fachada principal Cúpula / Main facade Dome

Fibes 1-02

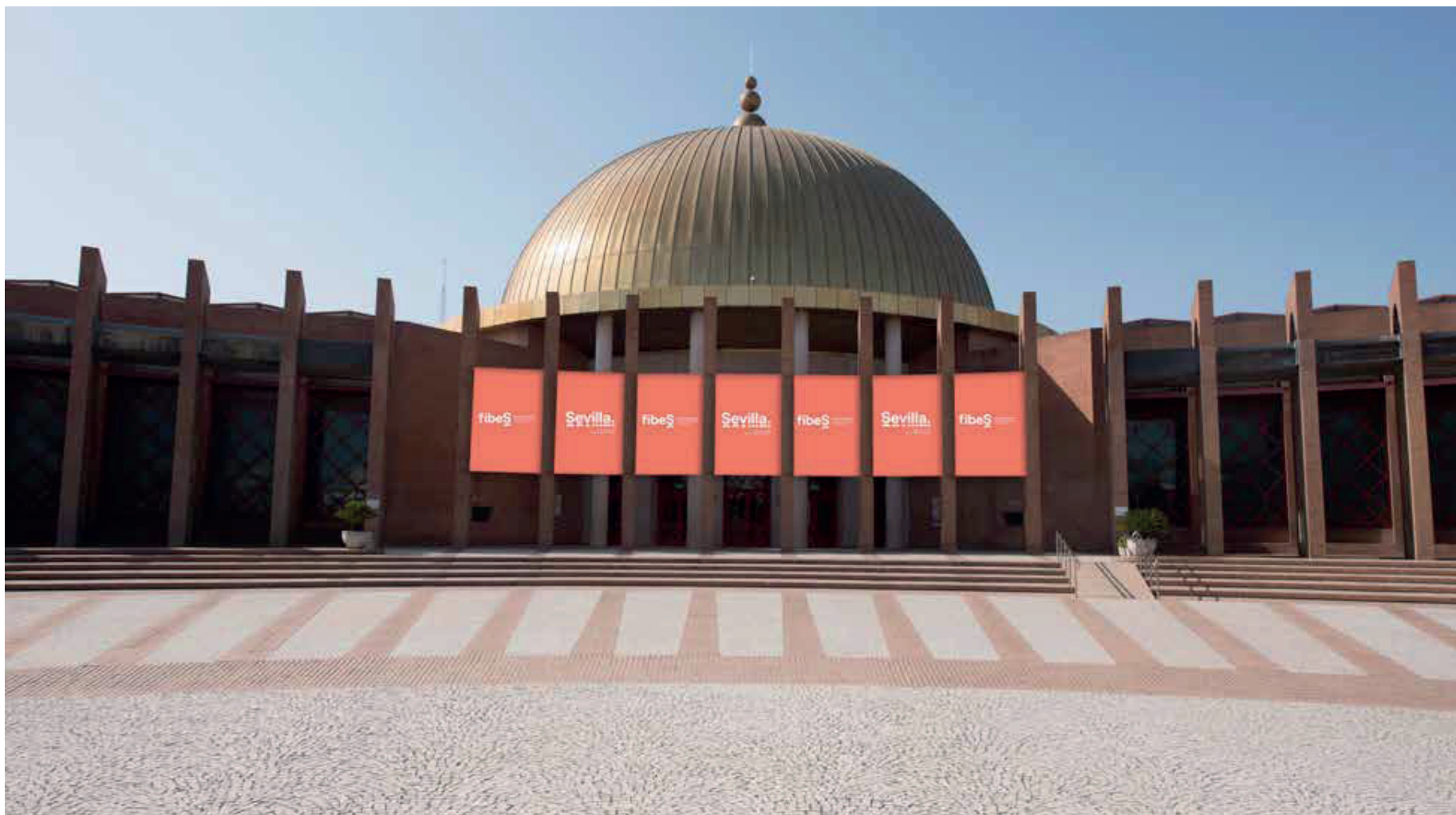

Material: Lona PVC microperforada con jaretón superior e inferior
Micro-perforated PVC canvas with upper and lower drawstring

Medidas: 2,54 X 3,98 m cada unidad
Measures: 2.54 X 3.98 m each unit

Cúpula / Dome

Fibes 1-03



Material: Lona PVC frontlit
PVC Frontlit Canvas

Medidas: 2,24 x 4,04 m lona corta y 2,24 x 5,54m lona larga
Measures: 2.24 x 4.04 m short canvas and 2.24 x 5.54 m long canvas

Cúpula / Dome

Fibes 1-04



Material: Lona larga PVC frontlit

Long frontlit PVC

Medidas: 2,12 X 9,00 m cada unidad

Measures: 2.12 X 9.00 m each unit

Cúpula / Dome

Fibes 1-05



Material: Lona balcón PVC frontlit
PVC Frontlit balcony canvas
Medidas: 2,24 x 1,53 m 1 Unidad
Measures: 2.24 x 1.53 m 1 unit

Entrada Pabellón / Pavilion Entrance



Material: Foam impreso 10 mm espesor

Printed 10 mm Foam

Medidas: 3,50 x 1,01 m

Measures: 3.50 x 1.01 m

Interior Pabellón / Inside Pavilion

Fibes 1-07



Material: Cubos gráficos realizados mediante estructura interna de madera con lonas PVC graficas exteriores
PVC Graphic Cubes. Inner structure in wood to cover with PVC printed Canvas (5 sides printed)

Medidas: 2,00 x 2,00 m 1 Unidad
Measures: 2.00 x 2.00 m 1 Unit

Interior Pabellón / Inside Pavilion

Fibes 1-08



Material: Lona PVC frontlit doble cara
PVC Frontlit Canvas. Double-sided printing

Medidas: 1,00 x 3,00 m 1 Unidad
Measures: 1.00 x 3.00 m 1 Unit

Entrada Auditorio Al-Andalus / Al-Ándalus Auditorium. Main Entrance

Fibes 1-09



Material: Lona PVC frontlit
PVC Frontlit Canvas
Medidas: 4,00 x 1,50 m
Measures: 4.00 x 1.50 m

Interior cúpula escaleras / Indoor Dome Hall

Fibes 1-10

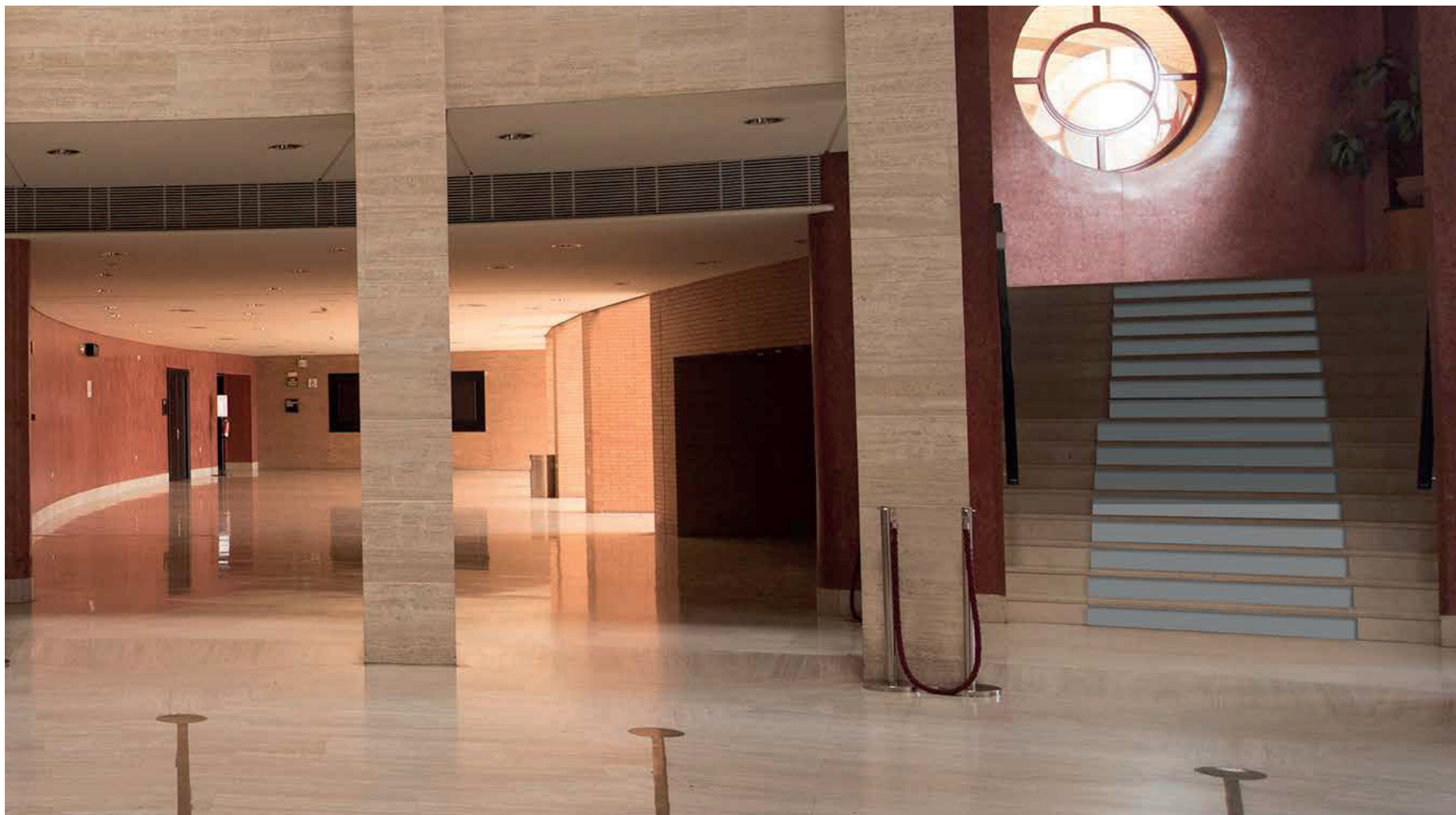

Material: Vinilo adhesivados sobre contrahuella escaleras acceso planta 1

Printed vinyl. Staircase to first floor

Medidas: 0,14 x 1,50 m

Measures: 0.14 x 1.50 m

02 Fibes 2

Fachada Rampa / Facade Ramp

Fibes 2-01



Material: Lona PVC frontlit. Realizada en tres paños unidos por termosellado

PVC Frontlit Canvas. Made in three cloths joined by heat sealing

Medidas: 16,00 x 6,05 m

Measures: 16.00 x 6.05 m

Fachada Rampa / Facade Ramp

Fibes 2-02



Material: Lona PVC frontlit. Realizada en una sola pieza

PVC Frontlit Canvas. Made in one piece

Medidas: 16,00 x 5,00 m

Measures: 16.00 x 5.00 m

Fachada Rampa / Facade Ramp

Fibes 2-03



Material: Lona PVC frontlit
PVC Frontlit Canvas

Medidas: 8,00 x 4,00 m
Measures: 8.00 x 4.00 m

Fachada Rampa / Facade Ramp

Fibes 2-04



Material: Vinilo impreso con laminado suelo

Printed vinyl flooring

Medidas: 3 m de diámetro

Measures: 3 m diameter

Fachada Rampa / Facade Ramp

Fibes 2-05



Material: Cubos gráficos realizados mediante estructura interna de madera con lonas PVC graficas exteriores

Graphical cubes made by internal structure of wood with graphics PVC

Medidas: 2,00 x 2,00 m 1 Unidad

Measures: 2.00 x 2.00 m 1 Unit

Terraza rampa barandilla exterior / Terrace ramp. Outdoor Railing

Fibes 2-06



Material: Lona PVC impresa grapeada a bastidor o fijada a barandilla

Printed PVC canvas engraved on rack or attached to railing

Medidas: 1 tramo: 13,60 x 1,10 m. 2 tramo: 14,14 x 1,10 m. 3 tramo: 15,70 x 1,10 m

Measures: 1 section: 13.60 x 1.10 m. 2 section: 14.14 x 1.10 m. 3 section: 15.70 x 1.10 m

Terraza 1 rampa interior / Terrace 1 interior ramp

Fibes 2-07



Material: Parte inferior: PVC con vinilo impreso. Parte superior: Lona PVC impresa con ollaos perimetral sobre barandilla o grapeada a bastidor de madera

Bottom: PVC with printed vinyl. Upper: PVC canvas printed with perimeter grommets on railing or woodgrain to wooden frame

Medidas: en la foto

Measures: in the photo

Terraza 2 rampa interior / Terrace 2 interior ramp

Fibes 2-08



Material: Lona PVC impresa con ollaos perimetral sobre barandilla o grapeada a bastidor de madera
Canvas PVC printed with perimetral grommets on railing or grating to wooden frame

Medidas: 9,84 x 1,10 m
Measures: 9.84 x 1.10 m

Terraza 3 rampa interior / Terrace 3 interior ramp

Fibes 2-09

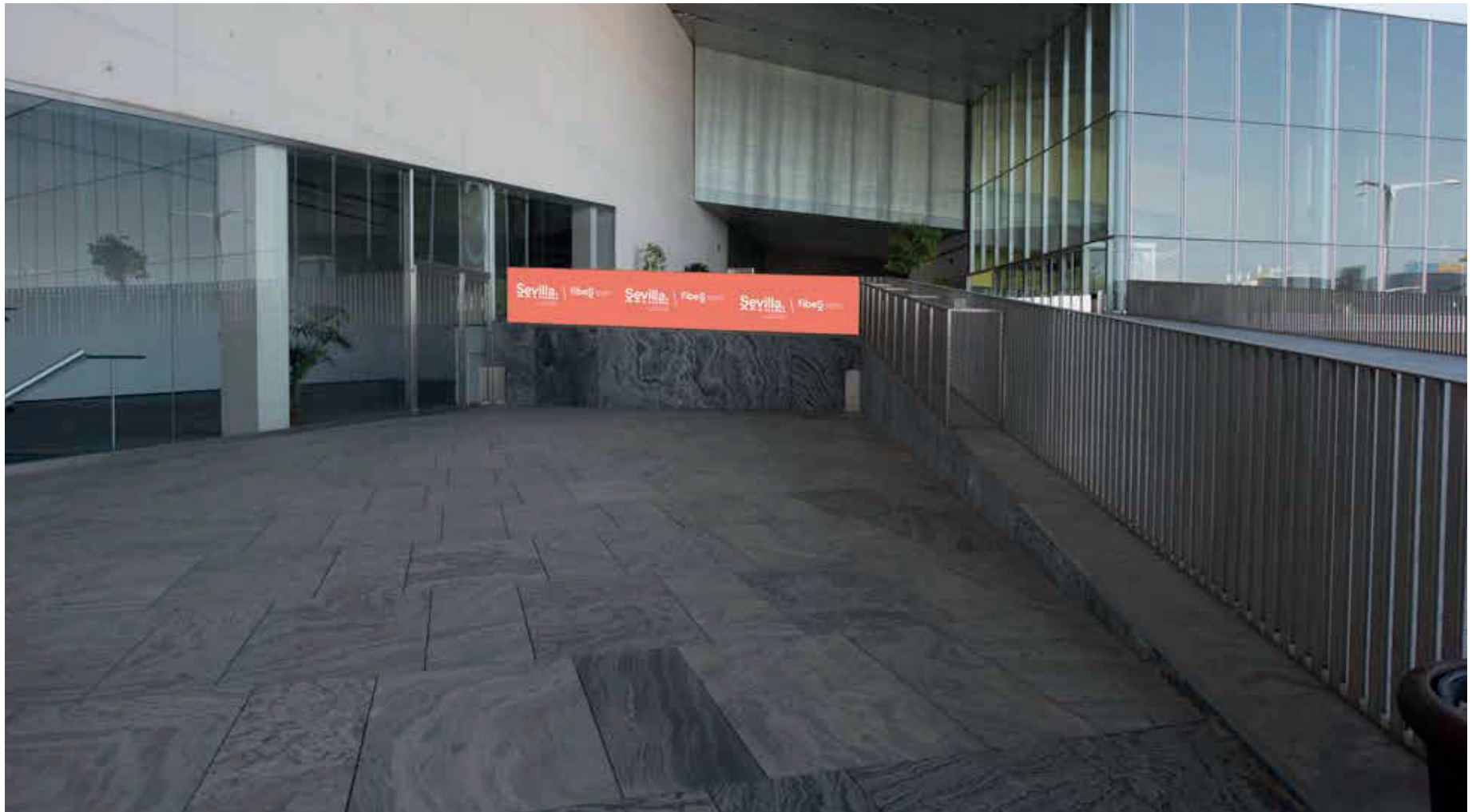

Material: Lona PVC impresa con ollaos perimetral sobre barandilla o grapeada a bastidor de madera

Canvas PVC printed with perimetral grommets on railing or grating to wooden frame

Medidas: 6,84 x 1,10 m

Measures: 6.84 x 1.10 m

Terrazas rampa interior. Puerta 1 / Terraces Indoor ramp. Gate 1

Fibes 2-10



Material: Vinilo microperforado
Microperforated vinyl

Medidas: ver foto
Measures: view photo

Terrazas rampa interior. Puerta 2 / Terraces Indoor ramp. Gate 2

Fibes 2-11



Material: Vinilo microperforado
Microperforated vinyl

Medidas: ver foto
Measures: view photo

Terrazas rampa interior. Puerta 3 / Terraces Indoor ramp. Gate 3

Fibes 2-12



Material: Vinilo microperforado
Microperforated vinyl

Medidas: ver foto
Measures: view photo

Módulo A interior / Indoor Module A

Fibes 2-13

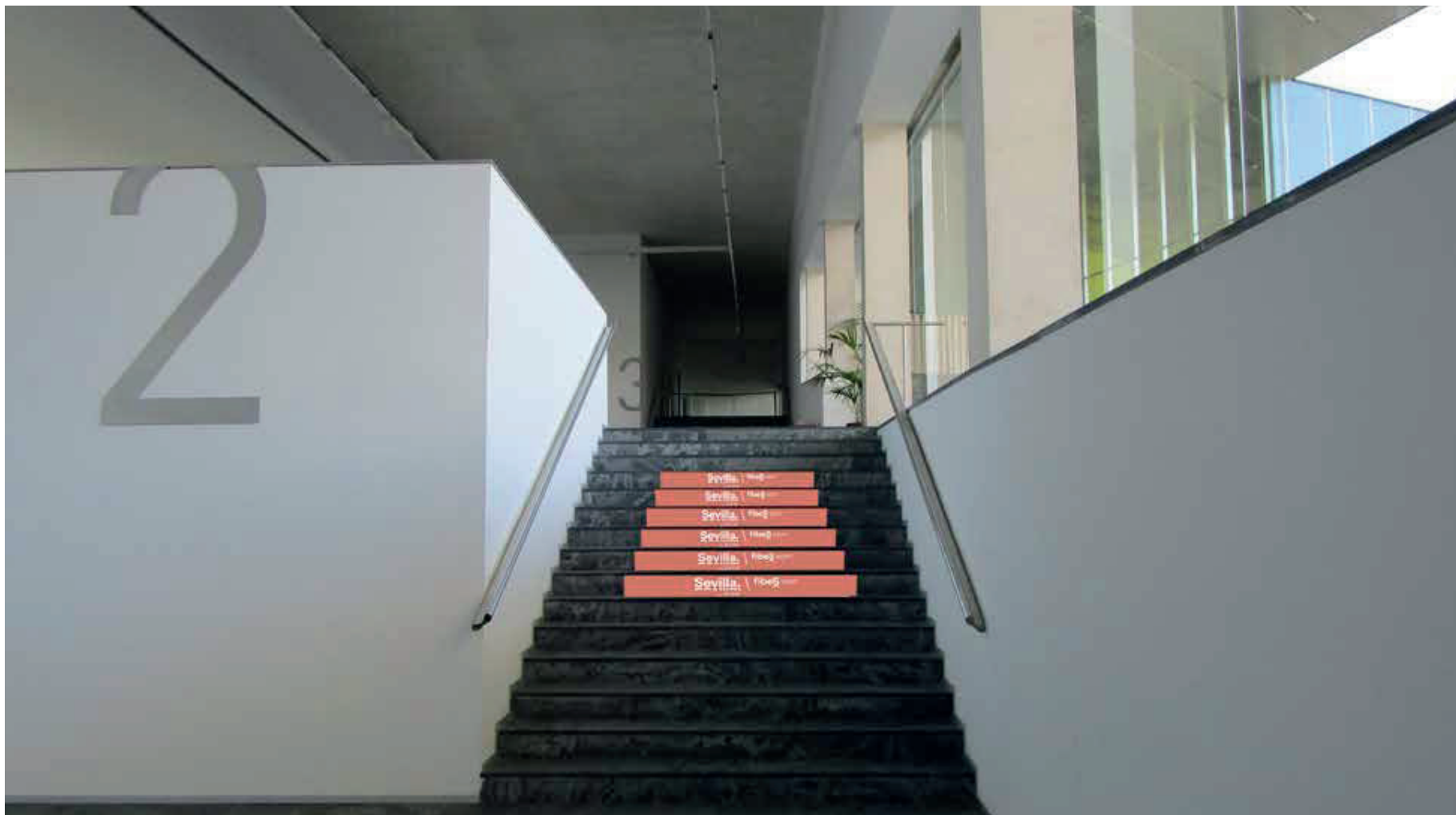

Material: Vinilo impreso/
Printed vinyl

Medidas: 0,15 m de altura por largo variable
Measures: 0.15 m height by variable length

Módulo A interior / Indoor Module A

Fibes 2-14



Material: Totems con impresión de vinilo

Totem display with printed vinyl

Medidas: 2,00 x 1,00 m x 3,70 m altura

Measures: 2.00 x 1.00 m x 3.70 m altura

Fachada Principal / Main Facade

Fibes 2-15



Material: Vinilo HOP cristal con trasera blanca opaca/

Vinyl HOP crystal with opaque white back

Medidas: 1,970 x 3,995 m. 1 Unidad de ventana

Measures: 1.970 x 3.995 m. 1 window unit

Zona Salida Parking / Exit Parking

Fibes 2-17



Material: Lona PVC frontlit impresa

PVC Frontlit Canvas

Medidas: 10,00 x 3,10 m

Measures: 10.00 x 3.10 m

Fachada Hall Planta 0 / Facade Ground Floor Hall 0

Fibes 2-18



Material: Vinilo microperforado ideal para cristales, permite una visión del 50% desde dentro hacia fuera

Micro-perforated vinyl ideal for glass, allows a 50% view from the inside out

Medidas: A= 1,86 x 4,22 m B= 1,67 x 4,22 m C= 1,67 x 4,08 m D= 1,67 x 4,08 m

Measures: A= 1.86 x 4.22 m B= 1.67 x 4.22 m C= 1.67 x 4.08 m D= 1.67 x 4.08 m

Fachada Hall Planta 0 / Facade Ground Floor Hall 0

Fibes 2-19



Material: Vinilo microperforado ideal para cristales, permite una visión del 50% desde dentro hacia fuera

Micro-perforated vinyl ideal for glass, allows a 50% view from the inside out

Medidas: 0,730 x 2,23 m

Measures: 0.730 x 2.23 m

Hall Planta 0. Acreditaciones / Ground Floor Hall. Accreditations

Fibes 2-20



Material: A y B vinilo impreso

A and B printed vinyl

Medidas: A=7,81 x 1,10 m / B= 5,19 x 0,75 m

Measures: A=7.81 x 1.10 m / B= 5.19 x 0.75 m

Hall Planta 0. Acreditaciones, Pasarela 1 / Ground Floor Hall. Accreditations. Footbridg_ .

Fibes 2-21



Material: Vinilo impreso sobre placas de aluminio

Printed vinyl on sheet

Medidas: 1 = 2,89 x 1,16 m / 2-7 = 2,81 x 1,16 m / 8 = 2,76 x 1,16 m. MEDIDA TOTAL: 22,51 x 1,16 m

Measures: 1 = 2.89 x 1.16 m / 2-7 = 2.81 x 1.16 m / 8 = 2.76 x 1.16 m TOTAL: 22.51 x 1.16 m

Hall Planta 0. Acreditaciones, Pasarela 2 / Ground Floor Hall. Accreditations. Footbridge

Fibes 2-22



Material: Vinilo impreso sobre placas de aluminio

Printed vinyl on sheet

Medidas: 1 = 2,66 x 1,16m/ 2 = 2,63 x 1,16m/ 4 3, 4, 5 = 2,67 x 1,16m/ 6 = 2,77 x 1,16m. TOTAL: 16,07 x 1,16 m

Measures: 1 = 2.66 x 1.16m/ 2 = 2.63 x 1.16m/ 4 3, 4, 5 = 2.67 x 1.16 m / 6 = 2.77 x 1.16m TOTAL : 16.07 x 1.16 m

Hall Planta 0. Pasarela 2 / Ground Floor Hall. Footbridge 2

Fibes 2-23



Material: Lona PVC fronlit fijada sobre barandilla superior

PVC Frontlit Canvas fixed on the upper railing

Medidas: 1= 2,67 x 2,13 m / 2=1,50 x 2,13 m visto, los anchos de las lonas son variables

Measures: 1= 2.67 x 2.13 m / 2=1.50 x 2.13 m seen, the widths of the canvases are variable

Hall Planta 0. Pasarela 3 / Ground Floor Hall. Footbridge 3

Fibes 2-24



Material: Vinilo impreso sobre placas de aluminio

Printed vinyl on sheet

Medidas: 1 = 3,54x 1,16 m/2-15 = 2,67x 1,16 m. MEDIDA TOTAL: 40,92 x 1,16 m

Measures: 1=3.54x1.16m/2-15=2.67x1.16m TOTAL: 40.92 x 1.16 m

Hall Planta 0. Pasarela 4. Zona Bar / Ground Floor Hall. Bar Area. Footbridge 4

Fibes 2-25



Material: Vinilo impreso sobre placas de aluminio

Printed vinyl on sheet

Medidas: 1-4 = 2,29 x 1,16 m / 5 = 2,40 x 1,16 m **MEDIDA TOTAL:** 11,56 x 1x16 m

Measures: 1-4 = 2.29 x 1.16 m / 5 = 2.40 x 1.16 m TOTAL SIZE: 11.56 x 1x16 m

Hall Planta 0. Pasarela 5. Zona Bar / Ground Floor Hall. Bar Area. Footbridge 5

Fibes 2-26



Material: Vinilo impreso sobre placas de aluminio

Printed vinyl on sheet

Medidas: 1 = 3,44x 1,16 m / 2-8 = 2,67x 1,16 m. MEDIDA TOTAL: 22,13 x 1,16 m

Measures: 1 = 3.44x 1.16 m / 2-8 = 2.67x 1.16 m. MEDIDA TOTAL: 22.13 x 1.16 m

Hall Planta 0 / Hall Floor 0

Fibes 2-27



Material: Vinilo HOP cristal con trasera blanca opaca

Vinyl HOP crystal with opaque white back

Medidas: 16,71 x 0,97 m

Measures: 16.71 x 0.97 m

Hall Planta 0. Zona bar / Hall Floor 0. Bar area

Fibes 2-28



Material: Vinilo HOP cristal con trasera blanca opaca

Vinyl HOP crystal with opaque white back

Medidas: 15,08 x 0,96 m

Measures: 15.08 x 0.96 m

Planta 0 a Planta 1. Escalera fija / Floor 0 to Floor 1. Fixed ladder

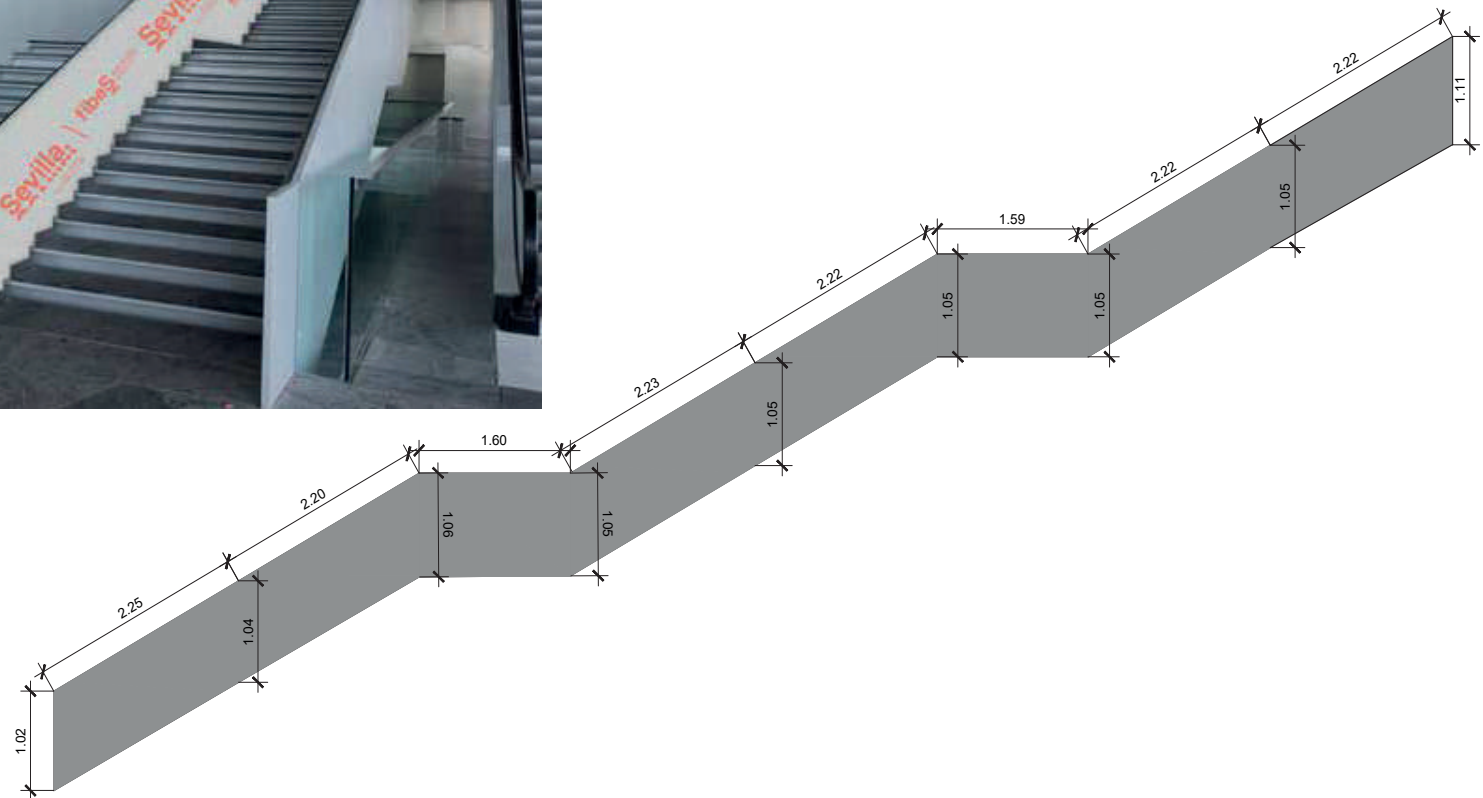

Fibes 2-29

Material: Vinilo HOP cristal con trasera blanca opaca
Vinyl HOP crystal with opaque white back

Medidas: ver plano
Measures: see map

Planta 0 a Planta 1. Escalera fija/ Floor 0 to Floor 1. Fixed ladder

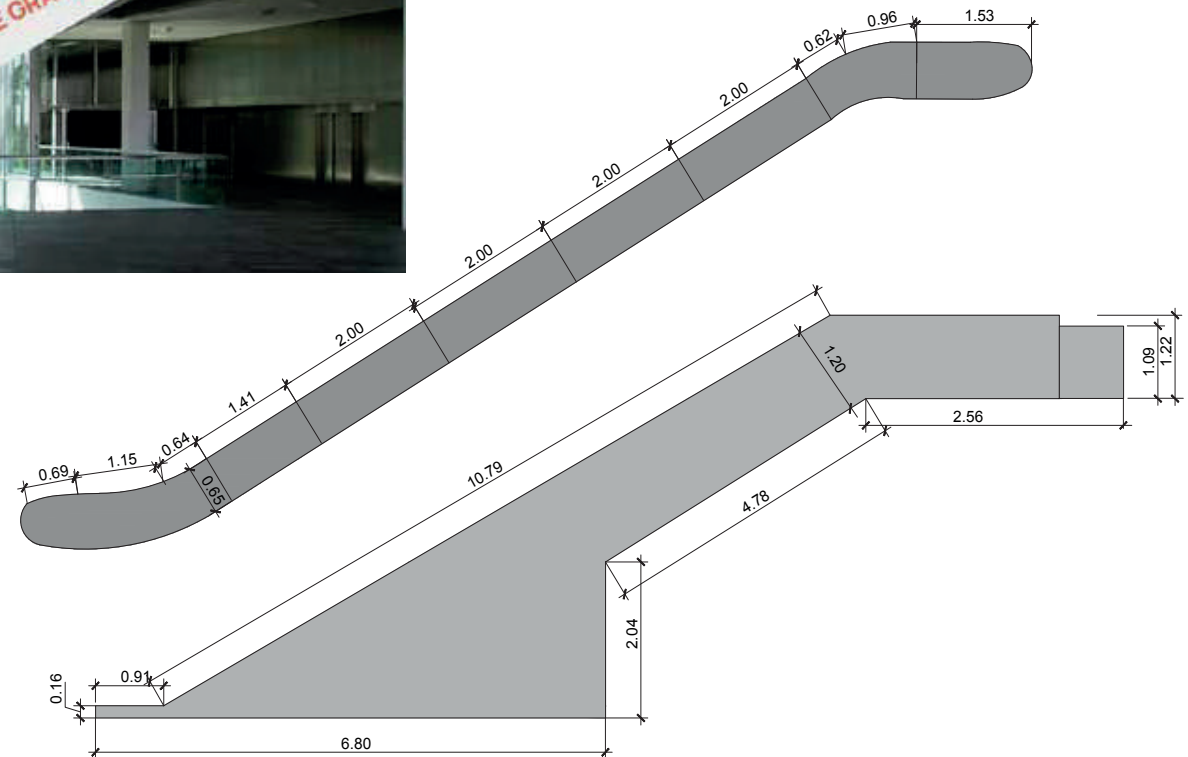
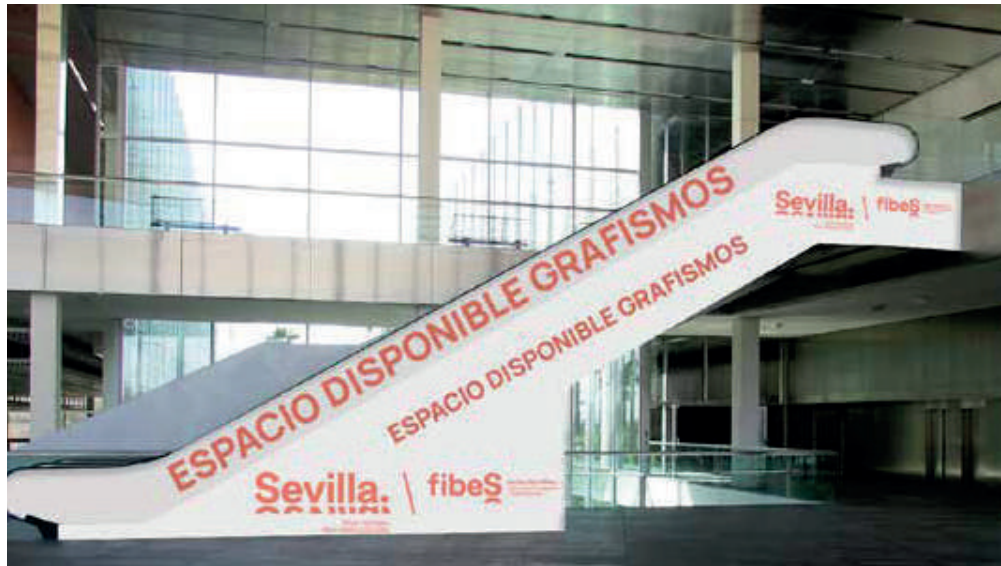

Fibes 2-30

Material: Vinilo HOP cristal con trasera blanca opaca
Vinyl HOP crystal with opaque white back

Medidas: ver plano
Measures: see map

Planta 1. Cristalera pasarela 3 / Floor 1. Glass Footbridge 3

Fibes 2-31



Material: Vinilo HOP cristal con trasera blanca opaca

Vinyl HOP crystal with opaque white back

Medidas: 40,74 x 0,97 m

Measures: 40.74 x 0.97 m

Rampa acceso Catering / Ramp. Area Catering access

Fibes 2-32



Material: Vinilo HOP cristal con trasera blanca opaca

Vinyl HOP crystal with opaque white back

Medidas: 32,10 x 0,97 m

Measures: 32.10 x 0.97 m

Zona Catering. Laterales / Catering Area. Sides



Fibes 2-33

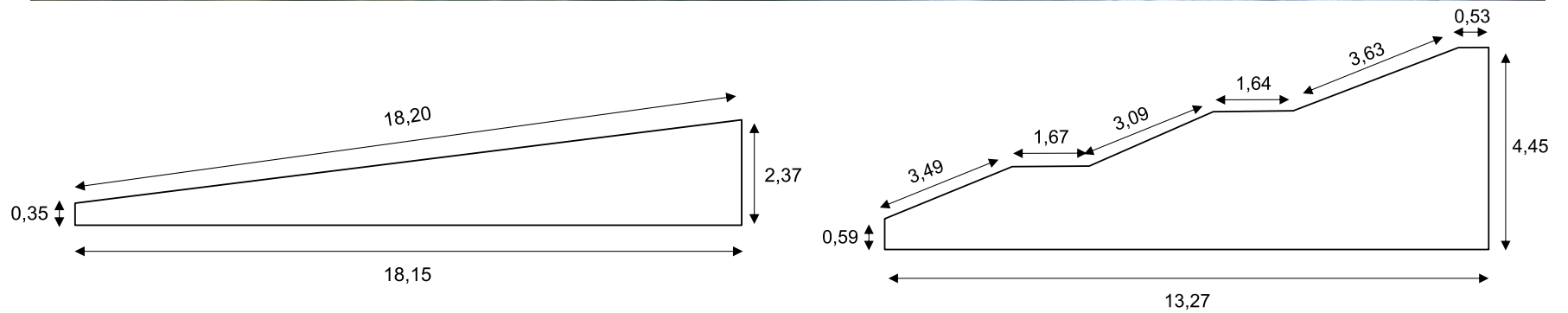

Material: Vinilo impreso/
Printed vinyl

Medidas: ver plano
Measures: see map

Zona Catering / Catering Area

Fibes 2-34

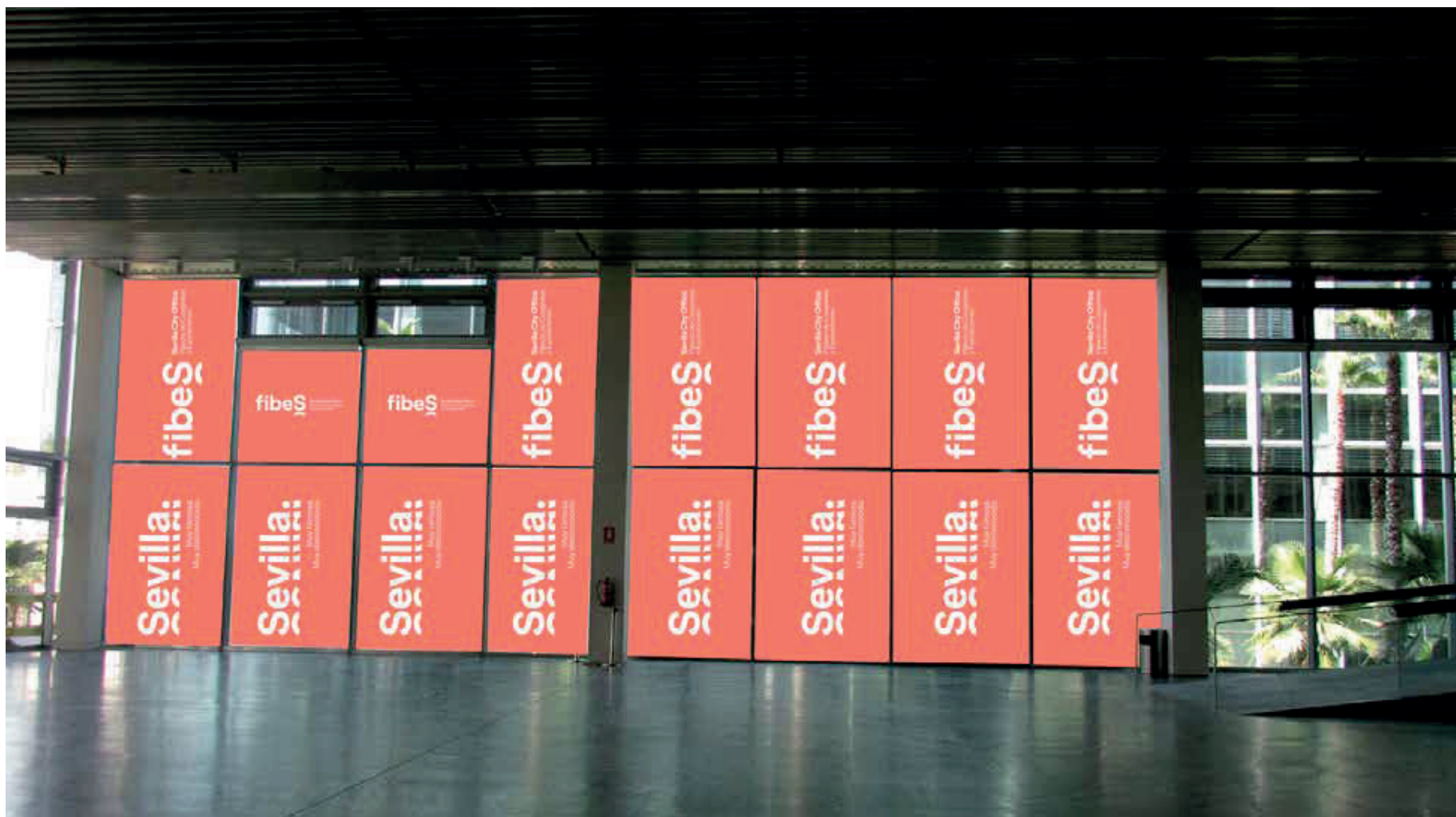

Material: Vinilo HOP cristal con trasera blanca opaca
Vinyl HOP crystal with opaque white back

Medidas: 8 uds: 2,43 x 4,15 m. 8 uds: 2,43 x 3,42 m
Measures: 8 units: 2.43 x 4.15 m 8 units: 2.43 x 3.42 m

Zona Catering. Pasarela / Catering Area. Footbridge

Fibes 2-35



Material: Lona gráfica pvc frontlit sobre dintel y fijado mediante soporte superior cada 10 m, se realiza por tramos

PVC Frontlit canvas on the lintel. Upper support-fixed and placed every 10 m, produced by sections

Medidas: 50,51 x 1,70 m

Measures: 50.51 x 1.70 m

Ascensores. Placa Señalética / Elevators. Signage plate

Fibes 2-36



Material: Foam 5mm espesor

Printed 5 mm Foam

Medidas: 0,16 x 0,31 m

Measures: 0.16 x 0.31 m

Planta 1. Aluminio subida escalera / Floor 1. Aluminum staircase climbing

Fibes 2-37



Material: Vinilo impreso

Printed vinyl

Medidas: 1,04 x 2,44 m

Measures: 1.04 x 2.44 m

Planta 1. Cristaleras salas panelables / Floor 1. Glass panels

Fibes 2-38



Material: Vinilo HOP cristal con trasera blanca opaca

Vinyl HOP crystal with opaque white back

Medidas: 2,44 x 3,43 m

Measures: 2.44 x 3.43 m

Planta 1 / Floor 1

Fibes 2-39



Material: Roll Up

Roll Up

Medidas: 1,00 x 2,00 m

Measures: 1.00 x 2.00 m

Planta 1 / Floor 1

Fibes 2-40



Material: Foam de 10 mm con vinilo impreso aplicado a doble cara

10mm Foam with printed double-sided vinyl

Medidas: 0,80 x 1,00 m

Measures: 0.80 x 1.00 m

Planta 1 / Floor 1

Fibes 2-41



Material: Vinilo impreso con laminado suelo

Printed vinyl with laminate flooring

Medidas: 0,80 x 0,80 m

Measures: 0.80 x 0.80 m

Planta 1. Salas despachos / Floor 1. Office rooms

Fibes 2-42



Material: Vinilo microperforado ideal para cristales, permite una visión del 50%

Micro-perforated vinyl ideal for glass, allows 50% vision

Medidas: 1,48 X 2,01 m. 1 Unidad

Measures: 1.48 X 2.01 m 1 unit

Planta 2. Pasillo despachos / Floor 2. Office foyers

Fibes 2-43



Material: Vinilo impreso

Printed vinyl

Medidas: 12,78 x 2,04 m

Measures: 12.78 x 2.04 m

03 Elementos Autoportantes / *Self-supporting Elements*

Photocall / Photocall

Elementos Autoportantes-1
Self-supporting Elements-1



Material: Lona impresa
Printed canvas

Medidas: 4,00 x 2,70 m
Measures: 4.00 x 2.70 m

Atril / lectern

Elementos Autoportantes-2
Self-supporting Elements-2



Material: Foam 5 mm con vinilo impreso

Foam 5 mm with printed vinyl

Medidas: 1 = 0,62 x 1,28 m / 2 = 0,64 x 0,64 m 1,16 m altura

Measures: 1 = 0.62 x 1.28 m / 2 = 0.64 x 0.64m 1.16 m height

Podium / Podium

Elementos Autoportantes-3
Self-supporting Elements-3



Material: Foam impreso 10 mm
Foam 10 mm with printed vinyl

Medidas: 0,96 x 1,52 m
Measures: 0.96 x 1.52 m

Display. Directorio / Display. Directory

Elementos Autoportantes-4
Self-supporting Elements-4



Material: Lona impresa
Printed canvas

Medidas: 1,80 x 2,40 m
Measures: 1.80 x 2.40 m

Podium / Podium

Elementos Autoportantes-5
Self-supporting Elements-5



Material: Foam impreso 10 mm
Foam 10 mm with printed vinyl

Medidas: 0,46 x 1,52 m
Measures: 0.46x1.52 m

Display / Display

Elementos Autoportantes-6
Self-supporting Elements-6



Material: 1 = Display gráfico vinilo impreso triangular a 2 caras. 2 y 3= Display vinilo impreso a una o doble cara

1 = Triangular vinyl graphic display printed on 2 sides. 2 and 3= Vinyl display printed on one or both sides

Medidas: 1= 0,46 X 2,58 m / 2= 0,95 X 2,58 m / 3= 0,46 x 2,58 m

Measures: 1= 0.46 X 2.58 m / 2= 0.95 X 2.58 m / 3= 0.46 x 2.58 m

Displays en zig-zag / Zig-zag displays

Elementos Autoportantes-7 Self-supporting Elements-7

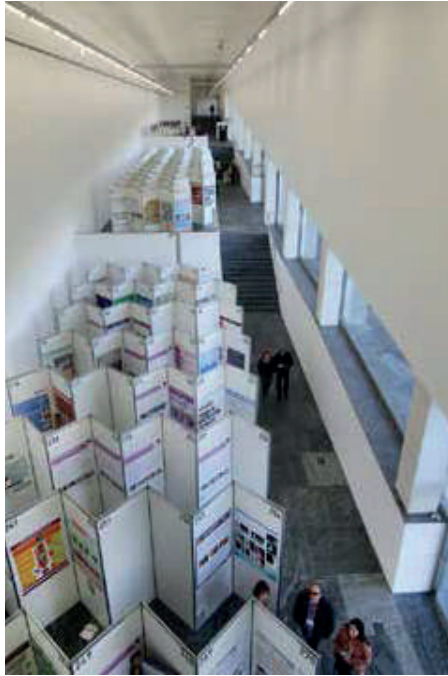

Material: Vinilo impreso

Printed vinyl

Medidas: 0,95 X 2,58 m 1 Unidad

Measures: 0.95 X 2.58 m 1 unit

04 Personalización Stand Modulares / *Custom Shell Scheme Graphic Solutions*

Stand 4 x 4 Perfileria vista / Shell scheme Stand 4 x 4 Visible poles

Personalización Stand Modulares-1
Custom Shell Scheme Graphic Solutions



Material: Vinilo impreso

Printed vinyl

Medidas: 1 = 0,95 x 2,58 m. 1 unidad / 2= 3,95 x 0,52 m

Measures: 1 = 0.95 x 2.58 m 1 unit / 2= 3.95 x 0.52 m

Stand 4 x 4 Perfilería oculta / Shell scheme Stand 4 x 4. Poles hidden

Personalización Stand Modulares-2
Custom Shell Scheme Graphic Solutions



Material: Foam impreso de 10 mm

Printed 10 mm foam

Medidas: 1 = 4,00 x 2,70 m / 2 = 3,95 x 0,52 m

Measures: 1 = 4.00 x 2.70 m / 2 = 3.95 x 0.52 m

Stand 3 x 3 Perfileria vista / Shell scheme Stand 3 x 3 Visible poles

Personalización Stand Modulares-3
Custom Shell Scheme Graphic Solutions



Material: Vinilo impreso

Printed vinyl

Medidas: 1 = 0,95 x 2,58 m 1 unidad / 2 = 2,95 x 0,52 m 1 unidad

Measures: 1 = 0.95 x 2.58 m 1 unit / 2 = 2.95 x 0.52 m 1 unit

Stand 3 x 3 Perfilera oculta / Shell scheme Stand 3 x 3 Poles hidden

Personalización Stand Modulares-4
Custom Shell Scheme Graphic Solutions



Material: Foam impreso de 10 mm

Printed 10 mm foam

Medidas: 1 = 3,00 x 2,70 m / 2 = 2,95 x 0,52 m

Measures: 1 = 3.00 x 2.70 m / 2 = 2.95 x 0.52 m

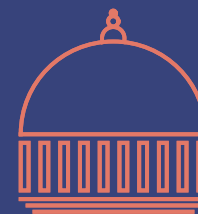

Avda. Alcalde Luis Uruñuela, 1 41020 Sevilla.

 954 47 87 00

 954 47 87 20

www.fibes.es